

# DSpace



13.6.2024

# Content

- Part 1 – Architecture (09:00 - 10:30)
  - Definitions, Demo
  - Architecture changes, FE – BE communication
  - New features, Angular in DSpace
  - DevOps, insights, collaboration
- Part 2 – Hands on (11:00 - 12:30)
  - Error case study
  - Import
  - Coding example (tool to show version info)
  - Deployment

# Part I – Architecture

Demo, FE – BE communication, New features, Angular, DevOps, insights, collaboration

All very technical – these slides will be available after

# A few definitions

- Important links in the last slide
- clarin-dspace v5 – DSpace currently used by CLARIN centres
- **clarin-dspace v7 – our implementation**
- Vanilla DSpace v7 – DSpace without modifications
  - init. est. 2017/2018, 7.0 released 2021, stable **2023**
- clarin-dspace v7 wiki – GitHub Wiki on dataquest DSpace repository
- DSpace Documentation – Lyrisis Vanilla DSpace documentation

# Demo – the new DSpace is familiar

- Home, Search, Item, Full-item – similar to v5
- Login, create community, collection, Item
- Some admin features – Health, License administration
- Authorization pages, bulk access edit
- What is new?
  - S3 + checksums
  - Live config reload
  - OpenAIRE complex input field
  - Item versions
  - DOI can be shown

# DSpace architecture changes

- XMLUI/JSPUI to Angular
- Java REST API
- Docker,
- Entity model
- Solr, Postgres – the same

# New features

- S3
- Configurable entities
- ORCID
- Docker
- DOI
- Admin "Health" menu
- OpenAIRE API
- OpenAIREv4
- Better support for IIIF
- The Submission Form configuration has changed
- Video/Image Content Streaming
- A completely new, fully featured REST API
- Support for Google Captcha

# Angular UI

- Theming (dspace/custom)
- Translations
- Static pages
- Accessibility - WCAG level AA
- Config



# Angular – BE communication

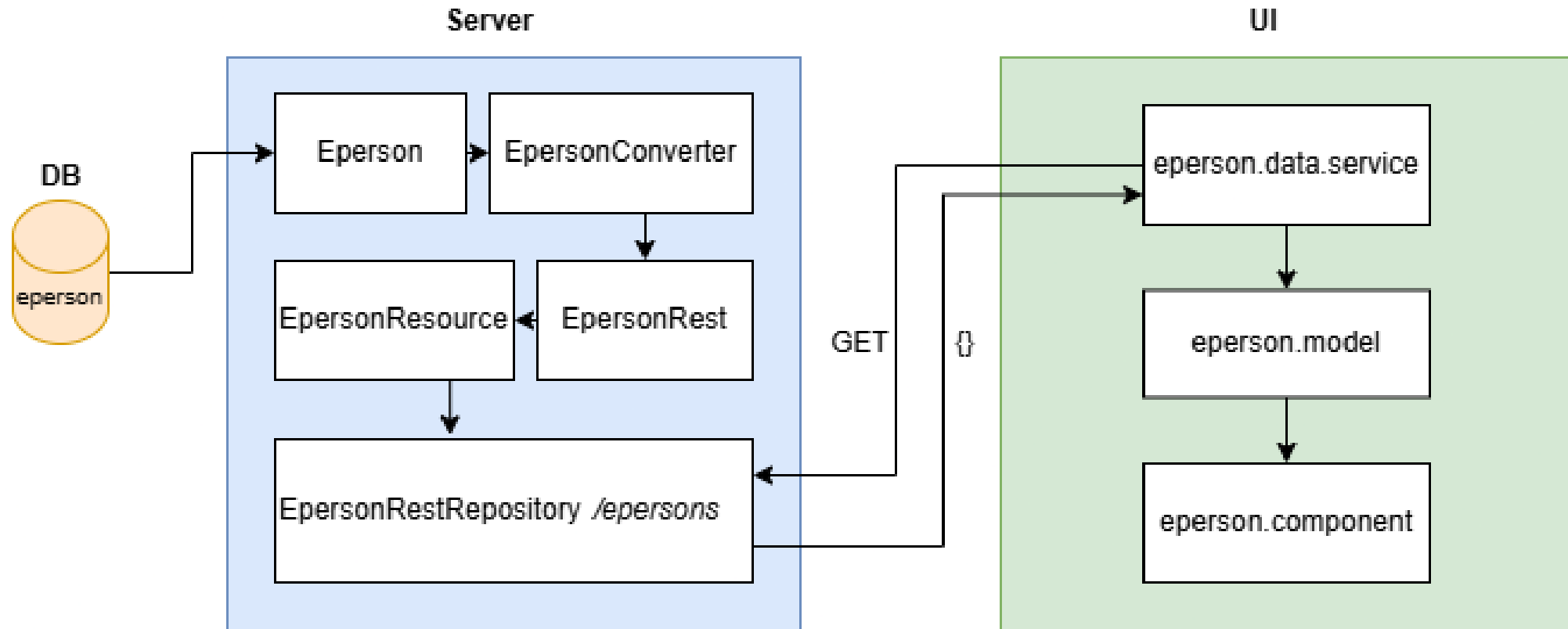

# Rendered configurable submission forms

- `submission-forms.xml`
- Configuration
- Dynamic components to render the configuration

# DevOps – our support for developers

- GitHub actions
  - Deploy to our local dev machines
  - Several Testing (automatic) workflows – unit, integration, UI, BE
  - Build and push
  - Import
  - Tagging for release
- Several instances – e.g., different flavours or setups
- Remote debug
- Use remote database

### Actions

New workflow

#### All workflows

- Build
- create\_bitstreams - import test files
- Deploy DSpace
- Docker images
- Erase database
- New issue assign
- Port merged Pull Request
- Pull Request opened
- Release
- Check for merge conflicts Disabled
- Show more workflows...

- Management
- Caches
- Attestations ↗
- Runners

### All workflows

Showing runs from all workflows

Filter workflow runs

| 3,643 workflow runs |   | Event                  | Status                       | Branch | Actor |
|---------------------|---|------------------------|------------------------------|--------|-------|
| <span>✓</span>      | <b>Deploy DSpace</b><br>Deploy DSpace #1394: Manually run by MajoBerger                             | dtq-dev                | 📅 2 days ago<br>🕒 1h 49m 45s |        | ...   |
| <span>✗</span>      | <b>Deploy DSpace</b><br>Deploy DSpace #1393: Manually run by MajoBerger                             | dtq-dev                | 📅 2 days ago<br>🕒 20s        |        | ...   |
| <span>✓</span>      | <b>Update deploy.yml (#636)</b><br>Docker images #1464: Commit 6b91cb5 pushed by MajoBerger         | dtq-dev                | 📅 2 days ago<br>🕒 1m 35s     |        | ...   |
| <span>✓</span>      | <b>Update deploy.yml (#636)</b><br>Build #1438: Commit 6b91cb5 pushed by MajoBerger                 | dtq-dev                | 📅 2 days ago<br>🕒 24m 56s    |        | ...   |
| <span>✓</span>      | <b>define varfor another job too</b><br>Docker images #1463: Pull request #636 opened by MajoBerger | internal/fix-var       | 📅 2 days ago<br>🕒 9m 20s     |        | ...   |
| <span>✓</span>      | <b>define varfor another job too</b><br>Build #1437: Pull request #636 opened by MajoBerger         | internal/fix-var       | 📅 2 days ago<br>🕒 25m 9s     |        | ...   |
| <span>✗</span>      | <b>Deploy DSpace</b><br>Deploy DSpace #1392: Manually run by MajoBerger                             | dtq-dev                | 📅 2 days ago<br>🕒 1h 38m 36s |        | ...   |
| <span>✓</span>      | <b>Added favicon.svg because it throws console error</b>  | ufal/added-favicon.svg | 📅 5 days ago                 |        | ...   |

# Production insights

- Logs
  - FE `pm2 monit` or `pm2 logs`
  - BE `/dspace/log/` (`dspace.log` and `warn.log`)
  - Solr `docker dspacesolr0 logs`
  - Nginx – on host, usually `/var/logs/nginx/`
- Monitoring tool – custom warnings and checks
- Configs – most in code, some mounted – enables hot reload
- Errors – in HANDS-ON section – how to find them
- Performance
  - FE needs a lot of resources – CPUs (cores) and RAM (mainly due to SSR)

- Quick Find
- Add Data
- All Capabilities
- All Entities
- Dashboards
- APM & Services
- Logs
- Traces
- Query Your Data
- Synthetic Monitoring
- Alerts
- Infrastructure**
- Errors Inbox
- Apps
- Metrics & Events
- Browser
- Lookout
- Recommendations
- Help
- Add User

- OVERVIEW
- Hosts** New
- Kubernetes
- Network
- Inventory
- Events
- INTEGRATIONS
- AWS
- Azure
- GCP
- Third-party services
- SETTINGS
- Alerts

Overview Classic List Navigator Lookout

Search by entity name Entity Type = Host

Suggested filters: ``operatingSystem` = 'linux'`

Summary System Network Processes Storage Docker containers

**Hosts** Filter **1**

**Applications** Filter **0**

**Events** Go to Events **10**

**Alerting** View activity stream **0** Critical **0** Warning

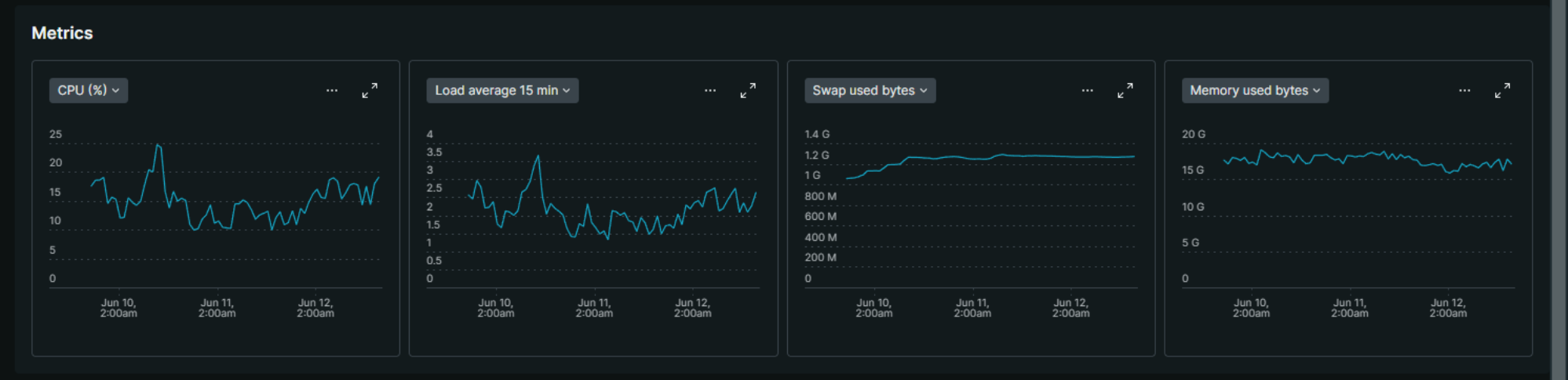

### Summary

| View           | Name                  | Applications | Agent version | CPU usage (%) | Memory usa... | Storage usag... | Network tran... | Network receive traffic (bytes/s) |
|----------------|-----------------------|--------------|---------------|---------------|---------------|-----------------|-----------------|-----------------------------------|
| <span>●</span> | <span>●</span> dspace | --           | 1.52.1        | 21.4%         | 51.04%        | 24.18%          | 2.27 MB/s       | 2.52 MB/s                         |

All logs

# Attributes

Partition (1) ▾

Search for Logs using Lucene

Query logs

NRQL

Saved views ▾

Since 3 days ago (GMT+2) live tail

Attributes

Patterns

MANAGE DATA

Drop filters

Parsing

Data partitions

Obfuscation

Lookup tables

## Attributes

Search 46 attributes

### RECENT

- filePath
- hostname
- httpversion
- logtype
- referrer

### APPLICATION ATTRIBUTES

- hostname

### ENTITY

- guid.INFRA
- guids

### VALUES

|             |       |
|-------------|-------|
| filePath    | 9     |
| hostname    | 1     |
| httpversion | 3     |
| logtype     | 6     |
| referrer    | 23.6k |
| hostname    | 1     |
| guid.INFRA  | 1     |
| guids       | 1     |

## Values

Search 9 values

### FILEPATH

- /var/log/nginx/access.log
- /var/lib/docker/volumes/tul-dspace\_dspace\_logs/\_data/warn.log
- /var/log/syslog
- /var/lib/docker/containers/66a7c50b524c7e17910f7f5e0647f7c2b950...921
- /var/log/auth.log
- /var/log/nginx/error.log
- /var/log/dpkg.log
- /var/lib/docker/containers/b818d1e8015f7bf4f5b4f478f7c40ac751a8dfc...6
- /var/log/alternatives.log

### LOGS

- 4.5m
- 1.7m
- 23.1k
- 529
- 336
- 63
- 6
- 1



Expand logs Expand table Add column Add to dashboard Export Manage parsing rules

| message   | filePath  |
|---|---|
| paceApiExceptionHandlerAdvice @ Authentication is required (status:401 exception: Access is denied at: org.springframework.security.a ccess.vote.AffirmativeBased.decide(AffirmativeBased.java:73))   |   |
| 2024-06-12 19:21:51,722 WARN 351a4a2f-db6a-482e-be02-d01f5c3a7e76 212caa22-337f-4d2b-853f-97cb0e58120e org.dspace.app.rest.exception.DS paceApiExceptionHandlerAdvice @ Authentication is required (status:401 exception: Access is denied at: org.springframework.security.a ccess.vote.AffirmativeBased.decide(AffirmativeBased.java:73)) | /var/lib/docker/volumes/tul-dspace_dspace_logs/_data/warn.log |
| 2024-06-12 19:21:51,730 WARN a7788000-2dbc-45eb-b3b7-f2637b3f360f 738f43b6-7fd7-40de-8f55-90b896c9b73f org.dspace.app.rest.exception.DS paceApiExceptionHandlerAdvice @ Authentication is required (status:401 exception: Access is denied at: org.springframework.security.a ccess.vote.AffirmativeBased.decide(AffirmativeBased.java:73)) | /var/lib/docker/volumes/tul-dspace_dspace_logs/_data/warn.log |
| 2024-06-12 19:21:51,730 WARN a7788000-2dbc-45eb-b3b7-f2637b3f360f f0283559-e64d-4f25-9e50-5f9ba87d1832 org.dspace.app.rest.exception.DS paceApiExceptionHandlerAdvice @ Authentication is required (status:401 exception: Access is denied at: org.springframework.security.a ccess.vote.AffirmativeBased.decide(AffirmativeBased.java:73)) | /var/lib/docker/volumes/tul-dspace_dspace_logs/_data/warn.log |
| 2024-06-12 19:21:51,740 WARN 351a4a2f-db6a-482e-be02-d01f5c3a7e76 09b86771-6167-43d8-93e3-0c9ceb681107 org.dspace.app.rest.utils.Utils @ Tried fetching resource: version for DSpaceObject with ID: 84a2742b-5290-41c9-8d09-fec819898193  | /var/lib/docker/volumes/tul-dspace_dspace_logs/_data/warn.log |
| 2024-06-12 19:21:51,858 WARN 351a4a2f-db6a-482e-be02-d01f5c3a7e76 a95ab665-5bd7-4725-92e0-0af32bc48869 org.dspace.app.rest.exception.DS paceApiExceptionHandlerAdvice @ Authentication is required (status:401 exception: Access is denied at: org.springframework.security.a ccess.vote.AffirmativeBased.decide(AffirmativeBased.java:73)) | /var/lib/docker/volumes/tul-dspace_dspace_logs/_data/warn.log |

# Experiences from development and deploy

- FE high load, caching, debugging, a lot of logs (nginx)
- Tests from upstream
- pm2 setup, monitoring, config, debug
- Logging too much
- Many requests in FE-BE communication
- Solr searching slightly modified compared to v5
- Nontrivial shibboleth integration – not DSpace, but can cause some issues
- Hardware requirements – much more than v5 or v6 (xmlui)



# Flow of development and collaboration

- Main repository is ufal – will be synchronized shortly after this presentation
- Contributing is easy
  - Issue
  - PR (to ufal repository)
  - We will do review and merge
- Possibly release – notes, tags, images
- Behind the scenes - for robustness and safety
  - Automatic testing, docker build and possibly deploy
  - Tests
    - Unit tests (BE and FE)
    - Integration tests – from Vanilla
    - Integration tests – REST API, playwright
    - test scenarios

Releases Tags

Draft a new release

Find a release

Mar 21

milanmajchrak

drruk-2024.03....

08956f1

Compare

# drruk-2024.03.8360397154

Latest



## What's Changed

- Fix mistakes in the /home page
- Fixed mistakes in the Item View page
- Fixed mistakes in the Search page
- Use `dc.contributor.other` metadata field for mapping the authors
- Added `edm.xml` registry
- Updated shibboleth cfg properties (firstname, lastname, netid, email)

## Assets 2

- Source code (zip) Mar 20
- Source code (tar.gz) Mar 20



Mar 21

milanmajchrak

none-2024.03....

f08b0eb

# CLARIN-DSpace 7.6.1 - 2024.03



## What's Changed

# Part II – Hands on

Error tracing, Import, BE + FE coding, deployment

# Error case study – big file upload

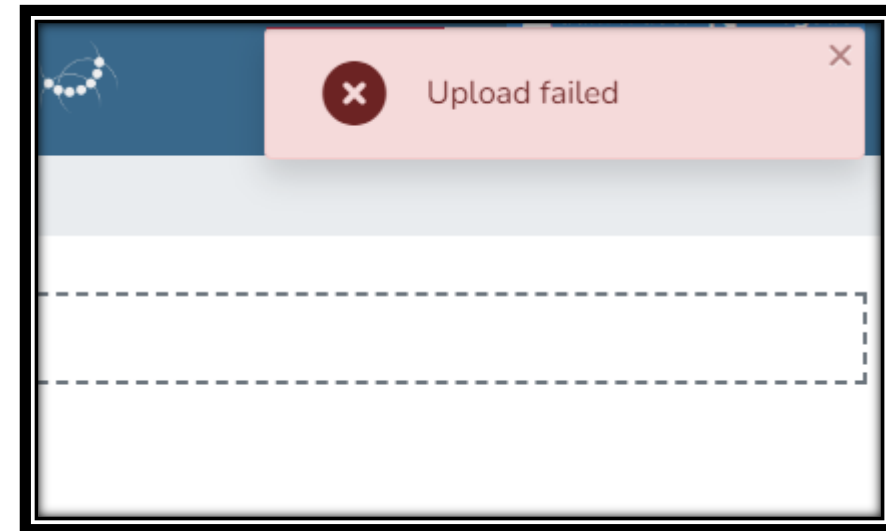
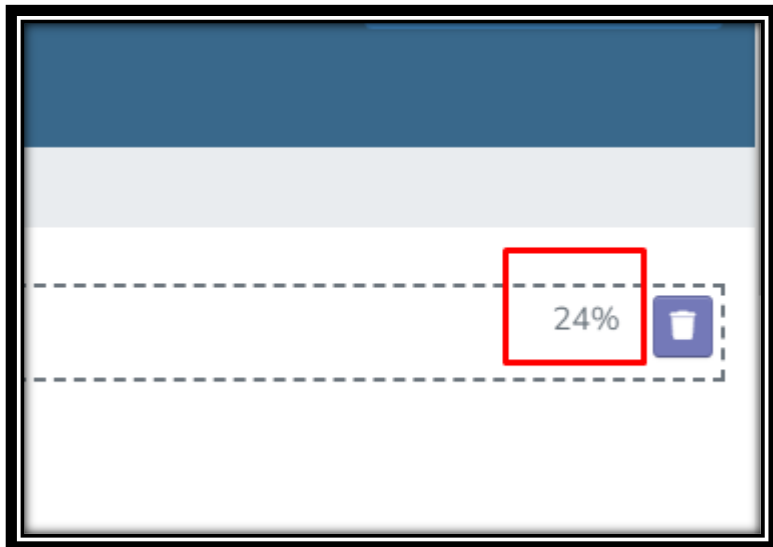
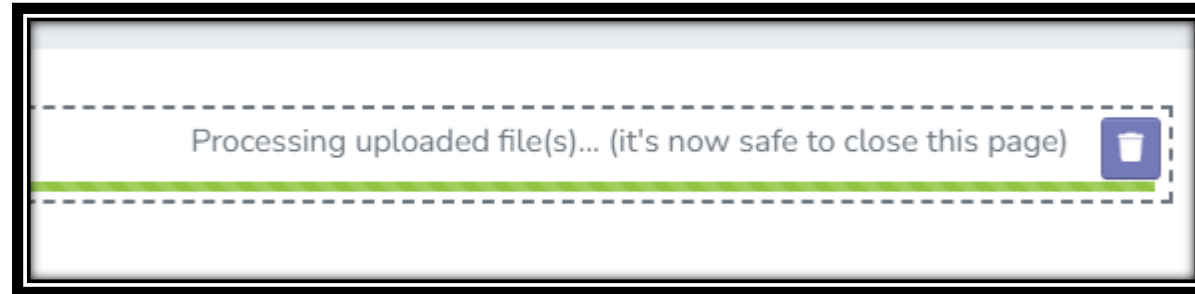

# Error case study – big file upload

- FE console – nothing
- FE logs in container – nothing
  - ``docker exec -it dspace-angular8 sh``
  - ``pm2 logs`` (add ``-n 500`` to show more (500) lines)
- BE logs in container
  - ``docker exec -it dspace8 bash``
  - ``tail /dspace/log/warn.log`` (or `.../dspace.log`)
  - (...) `DSpaceApiExceptionHandlerAdvice @ Maximum upload size exceeded (status:413 exception: Maximum upload size exceeded (...) the request was rejected because its size (5148576194) exceeds the configured maximum (4294967296) at: (...) .StandardMultipartHttpServletRequest (...)`

# Error case study – big file upload

- Config `clarin-dspace.cfg`
  - `spring.servlet.multipart.max-file-size = 6GB`
  - `spring.servlet.multipart.max-request-size = 4GB`
- Change the both to 6GB
  - No need to restart dspace due to hot reload?
  - Everything works?
  - IF it didn't help, try the restart the container
  - ``docker restart dspace8``
  - Hot reload does NOT always work. Some settings require restart.
  - Most errors you are expected to encounter will be misconfigurations

# Import - preparation

- Guide also in the links at the end checkout repository
- Checkout repository
  - <https://github.com/ufal/dspace-migrate>
- Checkout submodule: Python library – client that uses REST API
  - ``git submodule update --init libs/dspace-rest-python/``
- Obtain database dump
- TURN OFF MAIL SERVER
- Prepare new empty DSpace installation
  - (``dspace database migrate force`` must be run, but it is autorun in docker)
- Create administrator
- Install requirements
  - ``pip install -r requirements.txt``

# Import - execution

- Run DBs
  - ``scripts/start.local.dspace.db.bat``
- Convert dbs to JSONs
  - ``python db_to_json.py --database=clarin-dspace``
  - ``python db_to_json.py --database=clarin-utilities``
- Update ``project_settings.py`` (passwords, URLs etc.)
- Start import
  - ``python repo_import.py``
- Show logs (prepared, from another run)
  - Describe what is checked



# Import - result

- Logs in next slides

```
2024-06-10 16:16:35,143:INFO: Updating [backend.endpoint]->[http://dev-5.pc:88/server/api]
2024-06-10 16:16:35,143:INFO: Updating [db_dspace_7.port]->[5438]
2024-06-10 16:16:35,143:INFO: Updating [db_dspace_5.port]->[15432]
2024-06-10 16:16:35,143:INFO: Updating [db_utilities_5.port]->[15432]
2024-06-10 16:16:35,143:INFO: Updating [input.datadir]->[/opt/dspace-data/clarin-dspace//data/]
2024-06-10 16:16:35,143:INFO: Updating [input.icmdir]->[/opt/dspace-data/clarin-dspace//icon/]
2024-06-10 16:16:35,143:INFO: Initialise connection to DSpace REST backend [http://dev-5.pc:88/server/api]
2024-06-10 16:16:35,582:INFO: Authenticated successfully as test@test.edu
2024-06-10 16:16:35,583:INFO: DSpace REST backend is available at [http://dev-5.pc:88/server/api]
2024-06-10 16:16:35,583:INFO: Loading repo objects
2024-06-10 16:16:35,695:INFO: Loaded groups [{'1': ['503c9518-543a-448c-b074-3a4a492e1ad5'], '0': ['27d2b6ea-5daa-4efd-9622-4d4370a6c666']}], other groups:[0]
2024-06-10 16:16:37,038:WARNING: Ignoring metadata fields [[176]], len:[454870->123878]
2024-06-10 16:16:38,468:INFO: New instance database status:
2024-06-10 16:16:38,547:INFO:
    bitstreamformatregistry:      93
    checksum_results:             10
    dspaceobject:                 5
    entity_type:                  1
    eperson:                      2
    epersongroup:                 2
    epersongroup2eperson:         1
    fileextension:                111
    handle:                       1
    metadatafieldregistry:        304
    metadataschemaregistry:        20
    metadatavalue:                6
    resourcepolicy:               1
    schema_version:               67
    site:                          1
    user_registration:            2
```

```
2024-06-10 16:17:03,829:INFO: =====
2024-06-10 16:17:03,829:INFO: Importing [ 8] communities
2024-06-10 16:17:04,954:INFO: OK Imported [ 8] communities
2024-06-10 16:17:04,954:INFO: ===== Validating community =====
2024-06-10 16:17:04,956:INFO: Table [ community] OK compared by len only v5:[8], v7:[8]
2024-06-10 16:17:04,956:INFO: ===== Validating community2community =====
2024-06-10 16:17:04,957:INFO: Table [ community2community] OK compared by len only v5:[5], v7:[5]
2024-06-10 16:17:04,957:INFO:
*****

2024-06-10 16:17:04,957:INFO: =====
2024-06-10 16:17:04,957:INFO: Importing [ 13] collections

 0%|          | 0/13 [00:00<?, ?it/s]
100%|██████████| 13/13 [00:04<00:00, 3.22it/s]
2024-06-10 16:17:08,995:INFO: OK Imported [ 13] collections
2024-06-10 16:17:08,996:INFO: ===== Validating collection =====
2024-06-10 16:17:08,998:INFO: Table [ collection] OK compared by len only v5:[13], v7:[13]
2024-06-10 16:17:08,998:INFO: Table [ collection] !!! WARN !!! NON NULL [logo_bitstream_id] v5:[ 3], v7:[ 0]
2024-06-10 16:17:08,998:INFO: ===== Validating community2collection =====
2024-06-10 16:17:08,999:INFO: Table [community2collection] OK compared by len only v5:[13], v7:[13]
2024-06-10 16:17:08,999:INFO:
*****
```

```
2024-06-10 17:39:37,706:INFO: Took [4982.56] seconds to import all data
2024-06-10 17:39:37,706:INFO: Made [293] GET requests, [57647] POST requests.
2024-06-10 17:39:37,706:INFO: New instance database status:
2024-06-10 17:39:37,800:INFO:
```

```
    bitstream:      8175
  bitstreamformatregistry: 103
    bundle:        3501
  bundle2bitstream: 8098
  checksum_results: 10
    collection:    13
  collection2item: 2831
    community:     8
  community2collection: 13
  community2community: 5
  cwf_collectionrole: 4
    cwf_pooltask:  2
  cwf_workflowitem:  2
  dspaceobject:     16373
    entity_type:   1
    eperson:       1524
    epersongroup:  42
  epersongroup2eperson: 38
  fileextension:    111
    group2group:   56
  group2groupcache: 64
    handle:        8002
    item:          3109
```

```

2024-06-10 17:39:38,063:INFO: ===== Validating bundle =====
2024-06-10 17:39:38,067:INFO: Table [          bundle] OK compared by len only v5:[3501], v7:[3501]
2024-06-10 17:39:38,067:INFO: ===== Validating collection =====
2024-06-10 17:39:38,068:INFO: Table [          collection] OK compared by len only v5:[13], v7:[13]
2024-06-10 17:39:38,068:INFO: Table [          collection] OK  NON NULL [logo_bitstream_id] v5:[ 3], v7:[ 3]
2024-06-10 17:39:38,069:INFO: ===== Validating community2collection =====
2024-06-10 17:39:38,069:INFO: Table [community2collection] OK compared by len only v5:[13], v7:[13]
2024-06-10 17:39:38,069:INFO: ===== Validating community =====
2024-06-10 17:39:38,070:INFO: Table [          community] OK compared by len only v5:[8], v7:[8]
2024-06-10 17:39:38,070:INFO: ===== Validating community2community =====
2024-06-10 17:39:38,072:INFO: Table [ community2community] OK compared by len only v5:[5], v7:[5]
2024-06-10 17:39:38,072:INFO: ===== Validating eperson =====
2024-06-10 17:39:38,082:INFO: Table [eperson]: v5:[1523], v7:[1524]
    only in v5:[['None|None']]
    only in v7:[['.....', '.....']]
2024-06-10 17:39:38,083:INFO: ===== Validating epersongroup2eperson =====
2024-06-10 17:39:38,085:INFO: Table [epersongroup2eperson]: v5:[30], v7:[38]
    only in v5:[[]]
    only in v7:[['.....']]
2024-06-10 17:39:38,085:INFO: ===== Validating epersongroup =====
2024-06-10 17:39:38,086:INFO: Table [          epersongroup] !!! WARN !!! compared by len only v5:[34], v7:[42]
2024-06-10 17:39:38,086:INFO: Table [          epersongroup] !!! WARN !!!  NON NULL [eperson_group_id] v5:[ 34], v7:[ 0]
-----

```

# Demo example result

## Version info

Date

2024-05-24 10:00:12 +0200 This info was generated on: 2024-05-24 08:06:45.269719

Build run URL

<https://github.com/dataquest-dev/DSpace/actions/runs/9220644386>

Commit hash

2718a9273cbb086e129ac720bca4e4ad9c08a451

### [LINDAT/CLARIAH-CZ](#)

- [Mission Statement](#)
- [Advisory Board](#)
- [Events](#)

### [Partners](#)

- Charles University
- [Faculty of Mathematics and Physics](#)
- [Faculty of Arts](#)
- Czech Academy of Sciences
- [Czech Language Institute](#)
- [Library of Academy](#)

# Commits - BE

dataquest-dev / DSpace

Type to search

<> Code Issues 98 Pull requests 4 Discussions Actions Projects Wiki Security 47 Insights Settings

## Commits

utrecht-demo

All users

All time

Commits on Jun 3, 2024

Created a controller for exposing version info data via GET request.

milanmajchrak committed last week

599737e

Exposing version info via REST.

milanmajchrak committed last week

9eab5e0

Created service and its implementation for retrieving version information from the `VERSION_D.txt` file (created during a github action).

milanmajchrak committed last week

124722e

Created VersionInfo object which will contain information about the current DSpace version.

milanmajchrak committed last week

af18c1d

# Commits - FE

dataquest-dev / dspace-angular

Type to search

Code Issues 109 Pull requests 2 Discussions Actions Projects 1 Wiki Security 6 Insights Settings

## Commits

utrecht-demo-pr... All users All time

Commits on Jun 12, 2024

|   |         |      |    |
|---|---------|------|----|
| Created Test file for unit testing version-info component.<br>milanmajchrak committed 3 minutes ago                       | 92cb1b2 | Copy | <> |
| Created version-info module and component with translation messages and styling.<br>milanmajchrak committed 3 minutes ago | 3bdb122 | Copy | <> |
| Added routing for /version-info page.<br>milanmajchrak committed 4 minutes ago  | 43ca778 | Copy | <> |
| Created service for communicating with the server and processing its response.<br>milanmajchrak committed 4 minutes ago   | 91d4bcd | Copy | <> |
| Created version info wrapper where the response is mapped from the BE.<br>milanmajchrak committed 5 minutes ago           | 9241410 | Copy | <> |



# Demo example light analysis

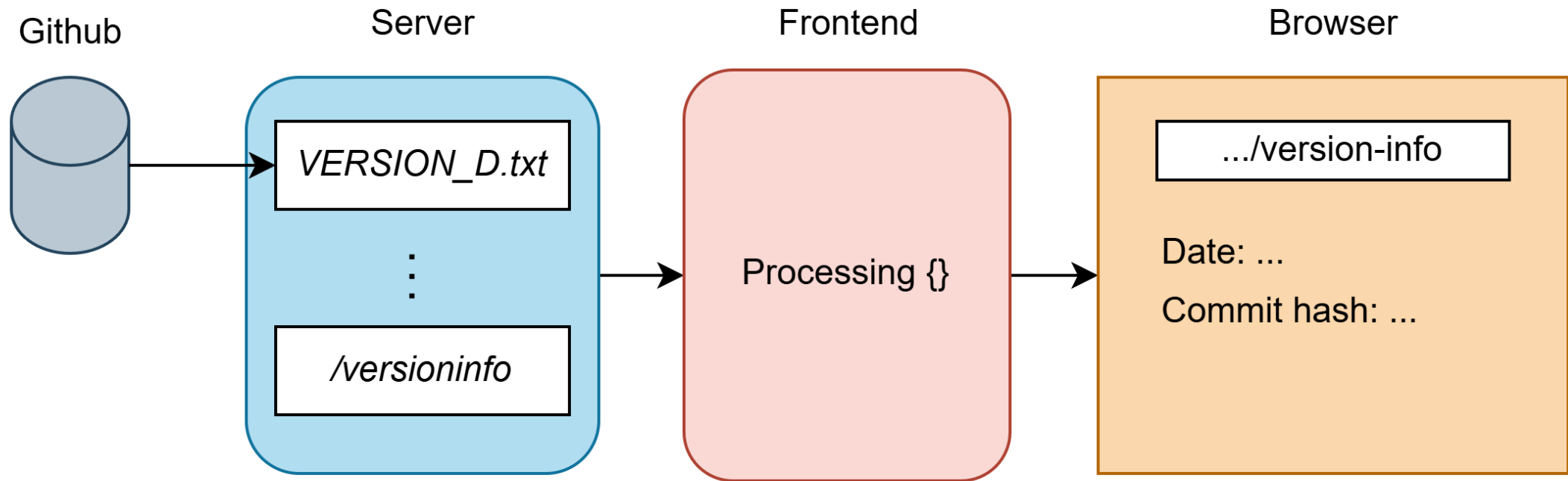

# BE analysis

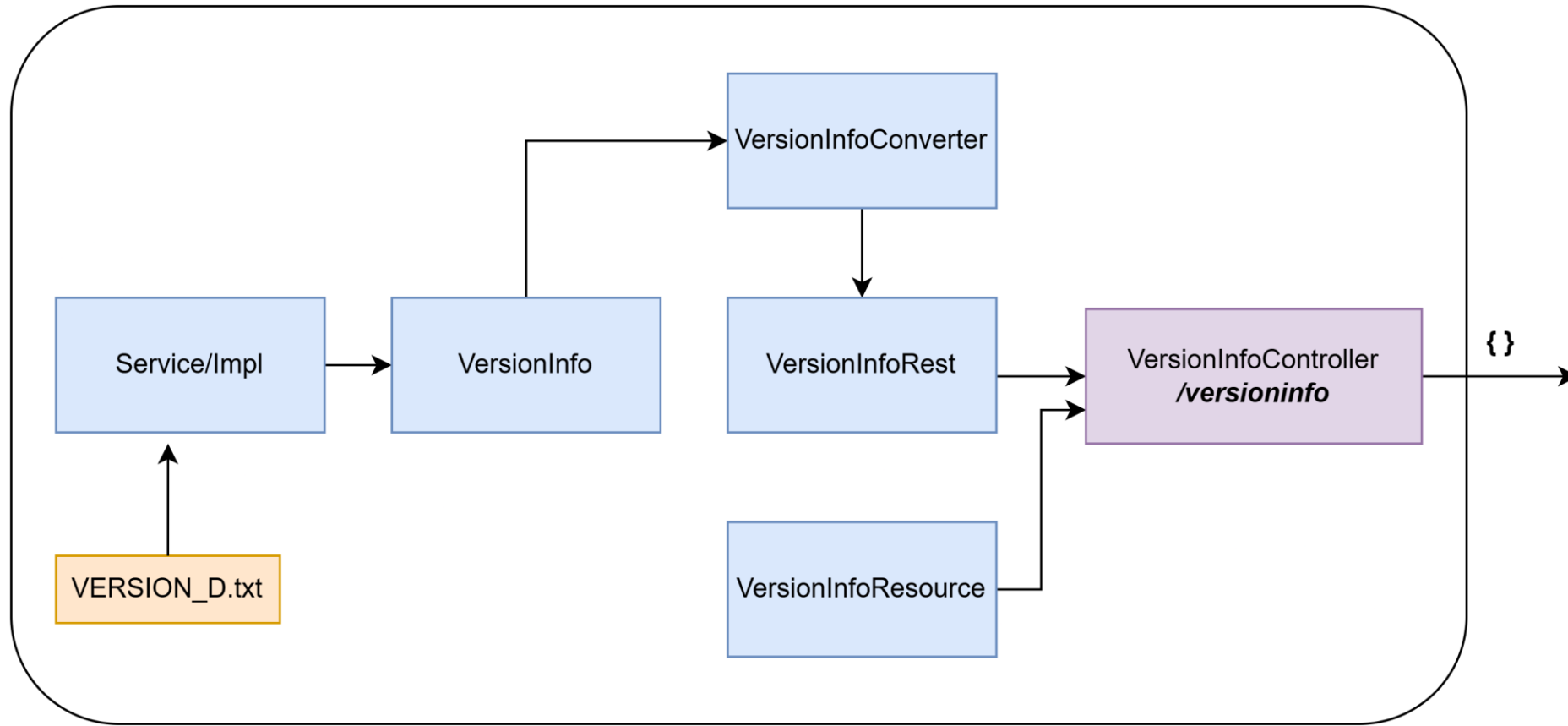

# FE analysis

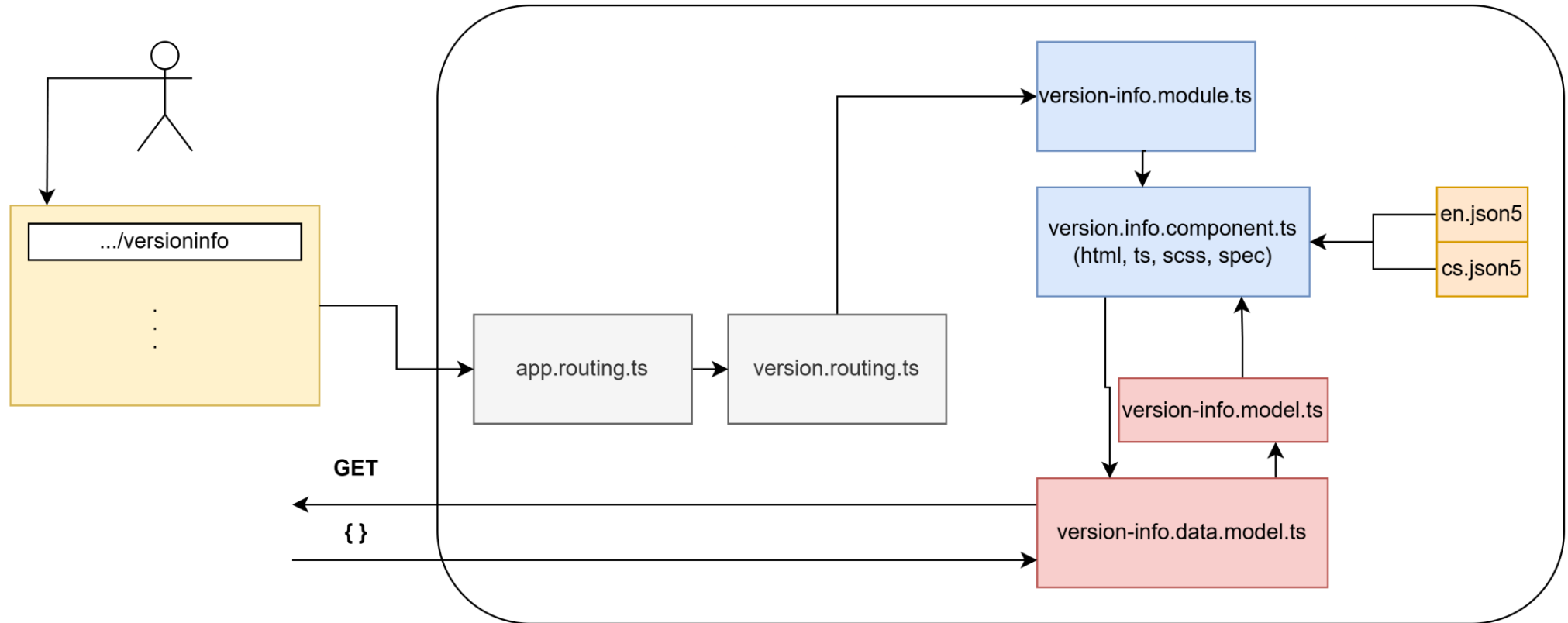

# Deployment example

- Git clone FE – locally
- Edit .env
- Compose up (explain when compose pull might be necessary)
- Show logs
- Go to page at end
- Configs, mounts, volumes
- Pm2 monit

# Links

- Main repository - ufal:
  - BE: <https://github.com/ufal/clarin-dspace/tree/clarin-v7>
  - FE: <https://github.com/ufal/dspace-angular/tree/clarin-v7>
  - Import: <https://github.com/ufal/dspace-migrate>
- Our DSpace wiki
  - <https://github.com/ufal/clarin-dspace/wiki>
- Vanilla Dspace documentation
  - <https://wiki.lyrasis.org/display/DSDOC7x>
- Import guide
  - <https://github.com/ufal/dspace-migrate/blob/main/README.md>
- Demo example commits
  - <https://github.com/dataquest-dev/DSpace/commits/utrecht-demo/>
  - <https://github.com/dataquest-dev/dspace-angular/commits/utrecht-demo-presentation>

Thank you for your attention

Milan Majchrák

Marián Berger

+ dataquest  
simply data